



ADVENTURE TECHNOLOGY

2015 PRODUCT CATALOG



DURAWEAVE™ WITH INNEGRA™

It's time for a new era of paddling. It's time for a technological advancement that takes whitewater paddles to a whole new level. It's time for a lighter, stronger, more durable, and safer paddle...it's time for a revolution. Introducing AT's new composite material Duraweave with Innegra.

BLADES MADE WITH DURAWEAVE ARE:

- Lighter, more buoyant, and have a lower swing weight
- More abrasion resistant and less likely to splinter, crack, or delaminate

SHAFTS MADE WITH DURAWEAVE ARE:

- Powerful, yet have a natural and forgiving flex
- Stronger and far less likely to break

IMPACT RESISTANCE

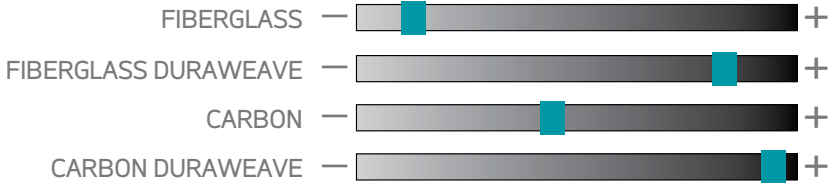

ABRASION RESISTANCE

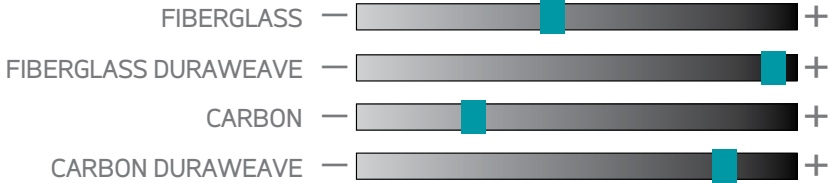

SECONDARY STRENGTH

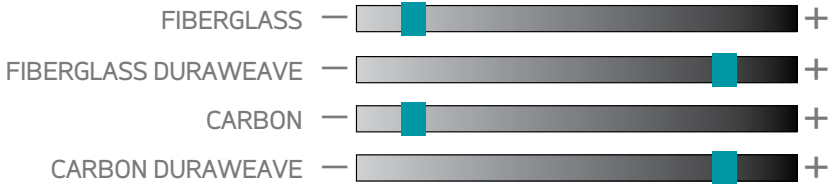

WEIGHT

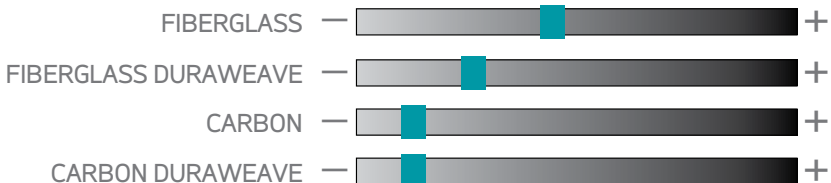

BLADE TECHNOLOGY

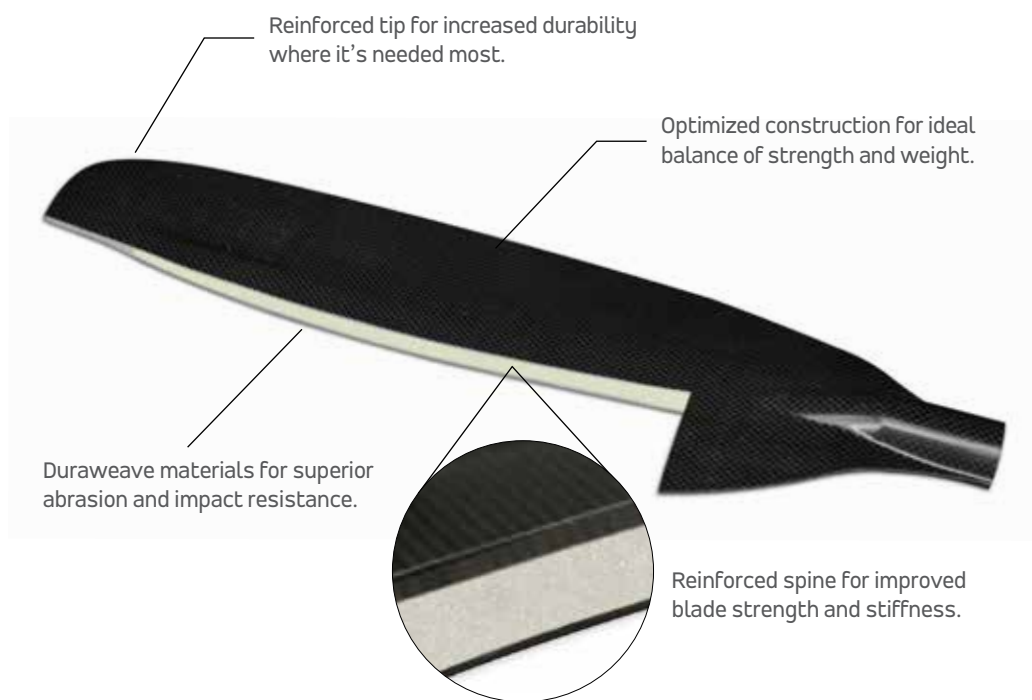

SHAFT TECHNOLOGY

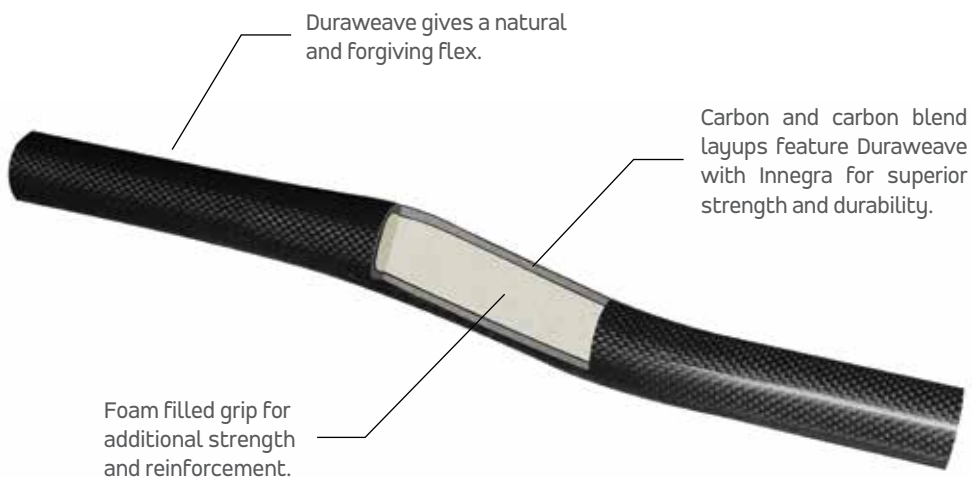

SECONDARY STRENGTH

Duraweave construction provides unparalleled secondary strength.

In the event that a shaft does crack, the unique molecular structure of Duraweave prevents cracks from spreading which significantly reduces the likelihood of complete shaft failure.

WHITEWATER ELITE SERIES

We've combined our best designs, features and technologies to provide superior performance. All Elite Series paddles come standard with light, buoyant foam core blades, durable Dynell blade trim, ergonomic Full Control Grip (FCG) shaft and unibody construction for strength and consistent flex. Our famous braided fiber construction takes ergonomics to the next level by providing shafts with multiple flex patterns allowing you to pick the stiffness or flexibility needed.

AT2 SUPERDUTY

Originally an underground legend, it is now available to all who seek the benchmark of excellence in paddles. It was designed with one thing in mind – awesome strength. The braided fiber shaft has extra reinforcement and features a *LIMITED LIFETIME WARRANTY.



LENGTH	191, 194, 197, 200; Custom Available
BLADE OFFSET	30-Degree Standard, Custom Available
WEIGHT	42 oz / 1191 g
SHAFT	Carbon & Aramid Braid; Additional Shaft Reinforcement; Unibody Construction; Full Control Grip; Standard Diameter
BLADE	Carbon; Foam Core; Dynell Trim; 710 cm ²

AT2 SUPERLIGHT

Full carbon-braided construction provides a seamless and sleek design. Don't be fooled by its pure aesthetics and streamlined design, the AT2 Superlight can stand up to the toughest creeks and the most daunting expeditions.



LENGTH	191, 194, 197, 200; Custom Available
BLADE OFFSET	30-Degree Standard, Custom Available
WEIGHT	40 oz / 1135 g
SHAFT	Carbon; Unibody Construction; Full Control Grip; Standard Diameter
BLADE	Carbon; Foam Core; Dynell Trim; 710 cm ²

AT2 STANDARD

The AT2 Standard is often compared to the AT2 Superlight – lightweight, versatile, and durable – but its unique three fiber construction makes it a stiffer alternative. A great choice for kayakers who desire one paddle that can do it all.



LENGTH	191, 194, 197, 200; Custom Available
BLADE OFFSET	30-Degree Standard, Custom Available
WEIGHT	43 oz / 1219 g
SHAFT	Carbon, Aramid, & Fiberglass Braid; Unibody Construction; Full Control Grip; Standard Diameter
BLADE	Carbon; Foam Core; Dynell Trim; 710 cm ²

AT2 FLEXI

The AT2 Flexi is our most flexible paddle shaft within the Elite Series and most closely resembles the natural feel of a wooden paddle. This design is perfect for those who seek high performance but also need a paddle that reduces wear and tear on the body.

LENGTH	191, 194, 197, 200; Custom Available
BLADE OFFSET	30-Degree Standard, Custom Available
WEIGHT	43 oz / 1219 g
SHAFT	Carbon & Fiberglass Braid; Unibody Construction; Full Control Grip; Standard Diameter
BLADE	Carbon; Foam Core; Dynell Trim; 710 cm ²



ATX FLEXI

Adventure Technology's first paddle is still an icon today. Like the AT2 Flexi, the ATX Flexi's fiber construction shaft has a natural feel with a larger 748 sq. cm. blade packing a powerful punch favored by committed creekers.

LENGTH	191, 194, 197, 200; Custom Available
BLADE OFFSET	30-Degree Standard, Custom Available
WEIGHT	42.5 oz / 1205 g
SHAFT	Carbon, Aramid, & Fiberglass Braid; Unibody Construction; Full Control Grip; Standard Diameter
BLADE	Carbon; Foam Core; Dynell Trim; 748 cm ²



EDDY STANDARD

The Eddy combines most of our premium paddle features with the price advantage of a fiberglass blade. Slightly buoyant PVC foam core and streamlined power face make for excellent blade control in a hole making the Eddy a favorite among playboaters.

LENGTH	191, 194, 197, 200; Custom Available
BLADE OFFSET	30-Degree Standard, Custom Available
WEIGHT	40 oz / 1135 g
SHAFT	Carbon, Aramid, & Fiberglass Braid; Unibody Construction; Full Control Grip; Standard Diameter
BLADE	Fiberglass; Foam Core; Dynell Trim; 710 cm ²



EDDY FLEXI

The Eddy Flexi is a more flexible version of the original Eddy. This is a great choice for those who desire the durable, yet buoyant fiberglass Eddy blade but prefer some extra flex in the shaft to lessen the potential for wear and tear on the body.

LENGTH	191, 194, 197, 200; Custom Available
BLADE OFFSET	30-Degree Standard, Custom Available
WEIGHT	40 oz / 1135 g
SHAFT	Carbon & Fiberglass Braid; Unibody Construction; Full Control Grip; Standard Diameter
BLADE	Fiberglass; Foam Core; Dynell Trim; 710 cm ²



WHITEWATER ADVANCED SERIES

We've taken strength, durability and performance to a whole new level with our Advanced Series whitewater paddles featuring Duraweave™ with Innegra™. Blades made with Duraweave are more impact and abrasion resistant than traditional fiberglass or carbon blades, and shafts made with Duraweave are stronger and far less likely to break. Each paddle is offered in a Carbon Duraweave and Fiberglass Duraweave option.

GERONIMO

Featuring our largest Advanced Series blade, the Geronimo is ideal for those who need the most power from each stroke and maximum control in any condition on the river. The Geronimo is ideal for shallow creeks where rocks may prevent full purchase or in any condition where every stroke is critical.



CARBON



GLASS

SHAFT TYPE	CARBON		GLASS	
	ERGO	STRAIGHT	ERGO	STRAIGHT
WEIGHT	35.5 oz 1006 g	32 oz 907 g	37 oz 1049 g	31 oz 879 g
BLADE MATERIAL	Carbon Duraweave w/ Innegra		Fiberglass Duraweave w/ Innegra	
SHAFT MATERIAL	Carbon Duraweave w/ Innegra		Carbon Blend Duraweave w/ Innegra	
LENGTH	ERGO: 185, 188, 191, 194, 197, 200; Custom Available STRAIGHT: 185, 188, 191, 194, 197, 200, 205, 210; Custom Available			
OFFSET	30-Degree Standard, Custom Available			
BLADE	725 cm ²			

HERCULES

The moderately sized, perfectly balanced blade is the most versatile in the Advanced Series whitewater line. Designed for the boater who spends a lot of time running rivers but likes to stop and play along the way, this paddle was designed for optimal all-around performance. Think of it as the little black dress of kayak paddles.



CARBON



GLASS

SHAFT TYPE	CARBON		GLASS	
	ERGO	STRAIGHT	ERGO	STRAIGHT
WEIGHT	35.5 oz 1006 g	32 oz 907 g	37 oz 1049 g	31 oz 879 g
BLADE MATERIAL	Carbon Duraweave w/ Innegra		Fiberglass Duraweave w/ Innegra	
SHAFT MATERIAL	Carbon Duraweave w/ Innegra		Carbon Blend Duraweave w/ Innegra	
LENGTH	ERGO: 185, 188, 191, 194, 197, 200; Custom Available STRAIGHT: 185, 188, 191, 194, 197, 200, 205, 210; Custom Available			
OFFSET	30-Degree Standard, Custom Available			
BLADE	700 cm ²			

SAMURAI

Featuring our smallest Advanced Series blade, the Samurai is ideal for paddlers who spend most of their time playboating, or for those who prefer a slightly smaller blade for all-around river running. Designed for quick and responsive strokes, the Samurai will deliver the kind of agile performance playboaters and river-runners expect.

SHAFT TYPE	CARBON		GLASS	
	ERGO	STRAIGHT	ERGO	STRAIGHT
WEIGHT	34.5 oz 978 g	31 oz 879 g	36.5 oz 1035 g	31 oz 879 g
BLADE MATERIAL	Carbon Duraweave w/ Innegra		Fiberglass Duraweave w/ Innegra	
SHAFT MATERIAL	Carbon Duraweave w/ Innegra		Carbon Blend Duraweave w/ Innegra	
LENGTH	ERGO: 185, 188, 191, 194, 197, 200; Custom Available STRAIGHT: 185, 188, 191, 194, 197, 200, 205, 210; Custom Available			
OFFSET	30-Degree Standard, Custom Available			
BLADE	675 cm ²			



CARBON



GLASS

WHITewater SPORT SERIES

The Sport Series is the perfect choice for those who seek performance at a value. Sport Series paddles feature a durable fiberglass shaft and tough fiberglass reinforced nylon blades.

TITAN

Inspired by the legendary AT2, the Titan is ideal for all purpose paddling. The moderately sized fiberglass reinforced nylon blade and fiberglass shaft deliver durability while keeping weight to a minimum. Add its bright, vibrant blade color for added visibility on the water, and you have the perfect paddle to inspire the beginner to intermediate paddler.

SHAFT TYPE	NYLON
	STRAIGHT
WEIGHT	37.5 oz / 1063 g
BLADE MATERIAL	Fiberglass Reinforced Nylon
SHAFT MATERIAL	Fiberglass
LENGTH	185, 188, 191, 194, 197, 200, 205, 210; Custom Available
OFFSET	30-Degree Standard, Custom Available
BLADE	660 cm ²

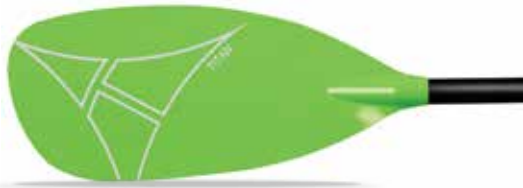

WHITEWATER PADDLE FEATURES

MODEL	WEIGHT (OZ)			SHAFT DIAMETER AVAILABILITY		UNIBODY CONSTRUCTION
	ERGO SHAFT	STRAIGHT SHAFT	LENGTH WEIGHED	STANDARD	SMALL	
ELITE SERIES						
AT2 Superduty	42.0	-	197 cm	Yes	-	Yes
AT2 Superlight	40.0	-	197 cm	Yes	-	Yes
AT2 Standard	43.0	-	197 cm	Yes	-	Yes
AT2 Flexi	43.0	-	197 cm	Yes	-	Yes
ATX Flexi	42.5	-	197 cm	Yes	-	Yes
Eddy Standard	40.0	-	197 cm	Yes	-	Yes
Eddy Flexi	40.0	-	197 cm	Yes	-	Yes
ADVANCED SERIES						
Geronimo Carbon	35.5	32.0	197 cm	Yes	Yes	-
Hercules Carbon	34.5	31.0	197 cm	Yes	Yes	-
Samurai Carbon	34.5	31	197 cm	Yes	Yes	-
Geronimo Glass	37.0	31	197 cm	Yes	Yes	-
Hercules Glass	37.0	31	197 cm	Yes	Yes	-
Samurai Glass	36.5	31	197 cm	Yes	Yes	-
SPORT SERIES						
Titan	-	37.5	197 cm	Yes	-	-

WHITEWATER PADDLE COMPARISON

ELITE SERIES

AT2 SUPERDUTY

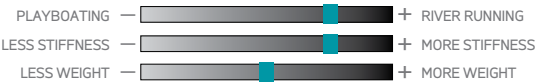

ATX FLEXI

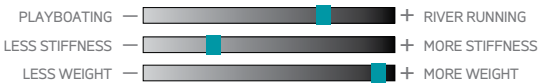

AT2 SUPERLIGHT

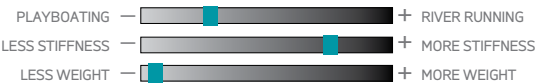

EDDY



AT2 STANDARD



EDDY FLEXI



AT2 FLEXI



ADDITIONAL SHAFT REINFORCEMENT	SHAFT MATERIAL	BLADE MATERIAL	BLADE EDGE PROTECTION	FOAM CORE BLADE	BLADE SIZE
Yes	Carbon & Aramid Braid	Carbon Fiber	Dynell Trim	Yes	710 cm ²
-	Carbon Fiber	Carbon Fiber	Dynell Trim	Yes	710 cm ²
-	Carbon, Aramid, & Fiberglass Braid	Carbon Fiber	Dynell Trim	Yes	710 cm ²
-	Carbon & Fiberglass Braid	Carbon Fiber	Dynell Trim	Yes	710 cm ²
-	Carbon & Fiberglass Braid	Carbon Fiber	Dynell Trim	Yes	748 cm ²
-	Carbon, Aramid, & Fiberglass Braid	Fiberglass	Dynell Trim	Yes	710 cm ²
-	Carbon & Fiberglass Braid	Fiberglass	Dynell Trim	Yes	710 cm ²
-	Carbon Duraweave with Innegra	Carbon Duraweave with Innegra	Duraweave	-	725 cm ²
-	Carbon Duraweave with Innegra	Carbon Duraweave with Innegra	Duraweave	-	700 cm ²
-	Carbon Duraweave with Innegra	Carbon Duraweave with Innegra	Duraweave	-	675 cm ²
-	Carbon Blend Duraweave with Innegra	Fiberglass Duraweave with Innegra	Duraweave	-	725 cm ²
-	Carbon Blend Duraweave with Innegra	Fiberglass Duraweave with Innegra	Duraweave	-	700 cm ²
-	Carbon Blend Duraweave with Innegra	Fiberglass Duraweave with Innegra	Duraweave	-	675 cm ²
-	Fiberglass	Fiberglass Reinforced Nylon	-	-	660 cm ²

ADVANCED SERIES

GERONIMO CARBON



GERONIMO GLASS



HERCULES CARBON



HERCULES GLASS



SAMURAI CARBON



SAMURAI GLASS



SPORT SERIES

TITAN



TOURING ELITE SERIES

The benchmark of excellence in touring paddles, the Elite Series includes the lightest and best performing touring paddles in the line. Loaded with all our premium features, these paddles are designed for superior performance, natural flex, and hours of paddling day after day.

XCEPTION SUPERLIGHT

The Xception Superlight offers superior performance in the lightest possible package. Featuring full carbon-braided construction, its versatile blade design is balanced, efficient and forgiving – a good choice for the well-rounded paddler who enjoys a variety of conditions and utilizes many stroke types.



LENGTH	210, 220, 230, 240
FERRULE	Unlimited Feathering; Adjustable Length
WEIGHT	27.0 oz / 766 g
SHAFT	Carbon; Unibody Construction; Full Control Grip; Standard Diameter
BLADE	Carbon; Foam Core; 565 cm ²

XCEPTION STANDARD

The Xception Standard features a unique blend of three shaft fibers for unparalleled durability. Versatile paddlers will appreciate the well-balanced, efficient and forgiving blade design when using different strokes in a variety of conditions.



LENGTH	210, 220, 230, 240
FERRULE	Unlimited Feathering; Adjustable Length
WEIGHT	29.0 oz / 822 g
SHAFT	Carbon, Aramid & Fiberglass Braid; Unibody Construction; Full Control Grip; Standard Diameter
BLADE	Fiberglass; Foam Core; 565 cm ²

EXODUS SUPERLIGHT

The Exodus Superlight features a lightweight full carbon braided construction. Its slightly larger blade is designed for more power without adding flutter. It's a great choice for those seeking the lightest available paddle for easier rolling, additional stability, and better grip in the water.

LENGTH	210, 220, 230, 240
FERRULE	Unlimited Feathering; Adjustable Length
WEIGHT	28.0 oz / 794 g
SHAFT	Carbon; Unibody Construction; Full Control Grip; Standard Diameter
BLADE	Carbon; Foam Core; 640 cm ²



EXODUS STANDARD

The Exodus Standard shaft combines three fibers for added durability, while its slightly larger blade is designed for power with minimal flutter. This combination makes for easy rolling and enhances stability and grip in the water.

LENGTH	210, 220, 230, 240
FERRULE	Unlimited Feathering; Adjustable Length
WEIGHT	30.0 oz / 851 g
SHAFT	Carbon, Aramid, & Fiberglass Braid; Unibody Construction; Full Control Grip; Standard Diameter
BLADE	Fiberglass; Foam Core; 640 cm ²



TOURING ADVANCED SERIES

One of the most dependable blades on the market, the Advanced Series offers premium composite materials combined to provide a lightweight and durable paddle available in both ergonomic or straight shafts.

QUEST

One of the most versatile touring paddles on the market featuring lightweight, woven carbon fiber construction, available with two carbon shafts to choose from. Ideal for paddlers who prefer a more relaxed stroke style and posture, but want the ability to paddle aggressively without any flutter.



CARBON



GLASS

SHAFT TYPE	CARBON		GLASS	
	FCG	STRAIGHT	FCG	STRAIGHT
WEIGHT	30.0 oz	29.0 oz	33.0 oz	31.0 oz
BLADE MATERIAL	Carbon Fiber		Fiberglass	
SHAFT MATERIAL	Carbon Fiber		Carbon Blend	
LENGTH	210, 220, 230, 240			
FERRULE	Unlimited Feathering; Adjustable Length			
BLADE	565 cm ²			

ODYSSEY

Slightly larger blade surface than the Quest with lightweight, woven carbon fiber construction in both straight and ergo shaft options. The oversized blade has a faster catch and substantially more purchase. Ideal for shorter trips, with quicker acceleration and more powerful strokes making it easier to roll decked kayaks and maneuver heavy sit-on-top kayaks.



CARBON



GLASS

SHAFT TYPE	CARBON		GLASS	
	FCG	STRAIGHT	FCG	STRAIGHT
WEIGHT	31.0 oz	30.0 oz	35.0 oz	33.0 oz
BLADE MATERIAL	Carbon Fiber		Fiberglass	
SHAFT MATERIAL	Carbon Fiber		Carbon Blend	
LENGTH	210, 220, 230, 240			
FERRULE	Unlimited Feathering; Adjustable Length			
BLADE	640 cm ²			

ORACLE

Our most powerful touring blade featuring lightweight carbon construction and two carbon shaft options. Its blade design has less dihedral than the Quest and Odyssey, providing a more powerful stroke and better stability when bracing or rolling in choppy conditions. Ideal for a more aggressive stroke style, the high angle blade improves boat control and maximizes stroke efficiency.



CARBON



GLASS

SHAFT TYPE	CARBON		GLASS	
	FCG	STRAIGHT	FCG	STRAIGHT
WEIGHT	30.0 oz	29.0 oz	34.0 oz	32.0 oz
BLADE MATERIAL	Carbon Fiber		Fiberglass	
SHAFT MATERIAL	Carbon Fiber		Carbon Blend	
LENGTH	Ergo: 205, 210, 215, 220, 225, 230 Straight: 205, 210, 215, 220, 225, 230, 235, 240			
FERRULE	Unlimited Feathering; Adjustable Length			
BLADE	610 cm ²			

TOURING SPORT SERIES

The Sport Series offers the perfect choice of paddles for those who seek performance and ergonomics at a value. Whether you're in the market for a high or low angled paddle, ergonomic or straight shaft, the Sport Series brings versatility, durability, and Adventure Technology performance to the entry-level or budget-conscious paddler.

PURSUIT GLASS

Ideal for low angle paddling, the Pursuit Glass features your choice of a carbon blend ergonomic shaft or straight shaft. In addition, our signature soft dihedral on the fiberglass reinforced nylon blade offers plenty of performance and versatility. New straight shaft, push-button model available with fiberglass shaft only.

SHAFT TYPE	GLASS		PUSH BUTTON
	ERGO	STRAIGHT	
WEIGHT	37.0	36.0	37.0
BLADE MATERIAL	Fiberglass Reinforced Nylon		
SHAFT MATERIAL	Carbon Blend		Fiberglass
LENGTH	210, 220, 230, 240		210, 220, 230, 240
FERRULE	Unlimited Feathering; Adjustable Length		45° Left - 0° - 45° Right
BLADE	605 cm ²		



SEARCH GLASS

The Search Glass is a high angle style blade featuring fiberglass reinforced nylon blades and your choice of a carbon blend ergonomic shaft or straight shaft. The blade is designed with less dihedral for added efficiency, an ideal paddle for all-around touring or well-conditioned paddlers. New straight shaft, push-button model available with fiberglass shaft only.

SHAFT TYPE	GLASS		PUSH BUTTON
	ERGO	STRAIGHT	
WEIGHT	37.5	36.5	37.5
BLADE MATERIAL	Fiberglass Reinforced Nylon		
SHAFT MATERIAL	Carbon Blend		Fiberglass
LENGTH	205, 210, 215, 220, 225, 230	205, 210, 215, 220, 225, 230, 235, 240	210, 220, 230, 240
FERRULE	Unlimited Feathering; Adjustable Length		45° Left - 0° - 45° Right
BLADE	602 cm ²		



PADDLEWAN

Designed specifically for kids with a light weight small diameter shaft with 0° to 60° adjustment. The smaller blades utilize the same lightweight, premium construction as our Pursuit Glass and Search Glass paddles.

SHAFT TYPE	PUSH BUTTON	
	STRAIGHT	
WEIGHT	26.5	
BLADE MATERIAL	Fiberglass Reinforced Nylon	
SHAFT MATERIAL	Fiberglass	
LENGTH	185, 195, 205	
FERRULE	Push Button; 3 Position Adjustable Feather Angle (60° Left - 0° - 60° Right)	
BLADE	426 cm ²	



TOURING PADDLE FEATURES

MODEL	WEIGHT (OZ)			SHAFT DIAMETER AVAILABILITY		UNIBODY CONSTRUCTION
	ERGO SHAFT	STRAIGHT SHAFT	LENGTH WEIGHED	STANDARD	SMALL	
ELITE SERIES						
Xception Superlight	27.0	-	220 cm	Yes	-	Yes
Exodus Superlight	28.0	-	220 cm	Yes	-	Yes
Xception Standard	29.0	-	220 cm	Yes	-	Yes
Exodus Standard	30.0	-	220 cm	Yes	-	Yes
ADVANCED SERIES						
Quest Carbon	30.0	29.0	220 cm	Yes	-	-
Odyssey Carbon	31.0	30.0	220 cm	Yes	-	-
Oracle Carbon	30.0	29.0	210 cm	Yes	-	-
Quest Glass	33.0	31.0	220 cm	Yes	-	-
Odyssey Glass	35.0	33.0	220 cm	Yes	-	-
Oracle Glass	34.0	32.0	210 cm	Yes	-	-
SPORT SERIES						
Pursuit Glass	37.0	36.0	220 cm	Yes	-	-
Pursuit Push-Button	-	37.0	220 cm	Yes	-	-
Search Glass	37.5	36.5	210 cm	Yes	-	-
Search Push-Button	-	37.5	220 cm	Yes	-	-
Paddlewan	-	26.5	195 cm	-	Yes	-

TOURING PADDLE COMPARISON

ELITE SERIES

XCEPTION SUPERLIGHT



EXODUS SUPERLIGHT



XCEPTION STANDARD



EXODUS STANDARD



ADVANCED SERIES

QUEST CARBON



ODYSSEY CARBON



ORACLE CARBON



QUEST GLASS



ODYSSEY GLASS

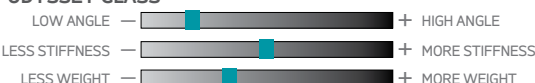

SHAFT MATERIAL		BLADE MATERIAL	FOAM CORE BLADE	BLADE SIZE
ERGO SHAFT	STRAIGHT SHAFT			
Carbon Fiber	-	Carbon Fiber	Yes	565 cm ²
Carbon Fiber	-	Carbon Fiber	Yes	640 cm ²
Carbon, Aramid, & Fiberglass Braid	-	Fiberglass	Yes	565 cm ²
Carbon, Aramid, & Fiberglass Braid	-	Fiberglass	Yes	640 cm ²
Carbon Fiber	Carbon Fiber	Carbon Fiber	-	565 cm ²
Carbon Fiber	Carbon Fiber	Carbon Fiber	-	640 cm ²
Carbon Fiber	Carbon Fiber	Carbon Fiber	-	610 cm ²
Carbon Blend	Carbon Blend	Fiberglass	-	565 cm ²
Carbon Blend	Carbon Blend	Fiberglass	-	640 cm ²
Carbon Blend	Carbon Blend	Fiberglass	-	610 cm ²
Carbon Blend	Carbon Blend	Fiberglass Reinforced Nylon	-	605 cm ²
-	Fiberglass	Fiberglass Reinforced Nylon	-	605 cm ²
Carbon Blend	Carbon Blend	Fiberglass Reinforced Nylon	-	602 cm ²
-	Fiberglass	Fiberglass Reinforced Nylon	-	602 cm ²
-	Fiberglass	Fiberglass Reinforced Nylon	-	426 cm ²

ORACLE GLASS



SPORT SERIES

PURSUIT GLASS



SEARCH GLASS



PADDLEWAN

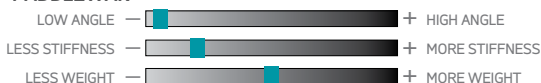

ANGLER SERIES

Fishing specific features and blade versatility designed for kayak angling. Especially functional with wider fishing kayaks and height adjustable seating systems.

EXODUS FISHSTIX

Used by the world's top kayak anglers, our Exodus Fishstix paddle features camouflage styling and a slightly larger blade for more stability and quicker acceleration in addition to all the standard Elite Series features.



LENGTH	210, 220, 230, 240
FERRULE	Unlimited Feathering; Adjustable Length
WEIGHT	30.0 oz / 851 g
SHAFT	Carbon, Aramid, & Fiberglass Braid; Unibody Construction; Full Control Grip; Standard Diameter
BLADE	Fiberglass; Foam Core; 640 cm ²

ODYSSEY ANGLER

The new Odyssey Angler features an oversized fiberglass blade for a faster catch and more purchase in the water, as well as a reinforced Duraweave™ tip for added abrasion resistance. The carbon blend straight shaft offers an additional 5cm in length adjustment for a total of 10cm and infinite feathering. Additional fishing features are abundant, such as measuring tape graphics, a line hook and high visibility aesthetics. Ideal for shorter trips requiring quick acceleration and powerful strokes, the Odyssey makes it easier to maneuver heavier sit-on-top angling kayaks.



LENGTH	220, 230, 240, 250, 260
FERRULE	Unlimited Feathering; Adjustable Length 0-10 cm
WEIGHT	33.5 oz / 950 g
SHAFT	Carbon Blend
BLADE	Fiberglass w/ Duraweave™ Reinforced Tip; 640 cm ²

ORACLE ANGLER

Our most powerful touring paddle has been transformed into a new high-performance angling paddle. Its blade design has less dihedral than the Odyssey Angler, providing an even more powerful stroke for ultimate control, with a Duraweave™ reinforced tip for superior abrasion resistance. Also featuring an extended ferrule for 10cm of length adjustment, unlimited feathering, and a measuring tape graphic on the carbon blend straight shaft, as well as a line hook and colorful digital camo graphic enhancements on the blade. Ideal for a more aggressive stroke style, the high angle blade improves boat control and maximizes stroke efficiency.

LENGTH	220, 230, 240, 250, 260
FERRULE	Unlimited Feathering; Adjustable Length 0-10 cm
WEIGHT	32.5 oz / 921 g
SHAFT	Carbon Blend
BLADE	Fiberglass w/ Duraweave™ Reinforced Tip; 610 cm ²



PURSUIT ANGLER

Ideal for any paddling style, the new Pursuit Angler features a signature fiberglass reinforced injection molded nylon blade for a full range of performance and versatility, and the same fully-adjustable ferrule system – allowing up to 10cm of length adjustment and unlimited feathering – found in the Advanced Angler carbon blend straight shafts. Measuring tape graphics and a line hook cutout are sure to give both beginner and intermediate anglers a competitive edge.

LENGTH	220, 230, 240, 250, 260
FERRULE	Unlimited Feathering; Adjustable Length 0-10 cm
WEIGHT	36.5 oz / 1035 g
SHAFT	Carbon Blend
BLADE	Fiberglass Reinforced Nylon; 605 cm ²



SEARCH ANGLER

Designed with the high angle paddler in mind, the new Search Angler features fiberglass reinforced nylon blades and a carbon blend straight shaft decked out with the same fishing-specific graphics and features introduced across the entire Angler series. The blade is designed with less dihedral for added power and control – an ideal paddle for heavier sit-on-top fishing kayaks or well-conditioned paddlers looking to paddle to harder to reach spots and fish all day.

LENGTH	220, 230, 240, 250, 260
FERRULE	Unlimited Feathering; Adjustable Length 0-10 cm
WEIGHT	37.0 oz / 1049 g
SHAFT	Carbon Blend
BLADE	Fiberglass Reinforced Nylon; 602 cm ²



ANGLER PADDLE FEATURES

MODEL	WEIGHT (OZ)			SHAFT DIAMETER AVAILABILITY		UNIBODY CONSTRUCTION
	ERGO SHAFT	STRAIGHT SHAFT	LENGTH WEIGHED	STANDARD	SMALL	
ELITE SERIES						
Fishstix	30.0	-	220 cm	Yes	-	Yes
ADVANCED SERIES						
Odyssey Angler	-	33.5	220 cm	Yes	-	-
Oracle Angler	-	32.5	220 cm	Yes	-	-
SPORT SERIES						
Pursuit Angler	-	36.5	220 cm	Yes	-	-
Search Angler	-	37.0	220 cm	Yes	-	-

ANGLER PADDLE COMPARISON

ELITE SERIES

FISHSTIX



ADVANCED SERIES

ODYSSEY ANGLER



ORACLE ANGLER



SHAFT MATERIAL		BLADE MATERIAL	FOAM CORE BLADE	BLADE SIZE
ERGO SHAFT	STRAIGHT SHAFT			
Carbon, Aramid, & Fiberglass Braid	-	Fiberglass	Yes	640 cm ²
-	Carbon Blend	Fiberglass w/ Duraweave™ Reinforced Tip	-	640 cm ²
-	Carbon Blend	Fiberglass w/ Duraweave™ Reinforced Tip	-	610 cm ²
-	Carbon Blend	Fiberglass Reinforced Nylon	-	605 cm ²
-	Carbon Blend	Fiberglass Reinforced Nylon	-	602 cm ²

SPORT SERIES

PURSUIT ANGLER



SEARCH ANGLER



NAVIGATING THE PRODUCT FEATURES

FULL CONTROL GRIP (FCG)

The foundation of Adventure Technology is our patented Full Control Grip (FCG). Designed with sports physiologists, the unique AT bent shaft design bends the shaft on two planes in order to properly align the bones in your forearms and wrists. It also has a more ergonomic grip area.

IMPROVED PERFORMANCE

ALIGNMENT – Ensures the bones in your forearms bear the load of each stroke, not the easily-tweaked ligaments taxed by conventional designs.

INDEXING – The uniquely shaped grip area allows for a more natural hand position. If the shaft does not fit your grip then there is extra fatigue on your joints and ligaments with every stroke. The bottom of the grip area is flat which matches the flat part of the fingers that wrap around and catch this part of the paddle.

LESS SLIP – Indexing along with the shaft's natural bend orients the paddle in your hand even during extreme bracing or rolling situations. Experience the confidence of always knowing correct hand placement especially when it matters most.

NATURAL GRIP – FCG allows you to quickly find or recover hand placement on your paddle, and continue to grip it comfortably all day without wrist and forearm fatigue, and allows the user full control of blade position.

REDUCED WEAR & TEAR ON BODY

- **LESS INJURIES** – Your wrist is completely neutral as you pull through the most powerful phase of the stroke, allowing stronger forearm bones to bear the load.
- **LESS FATIGUE** – Ergonomics means more efficiency with each stroke and less grip pressure so you can paddle in comfort all day long.

UNIBODY CONSTRUCTION

Select AT paddles feature a full one-piece construction—the shaft construction is woven directly from the shaft to the tip of the blade—for improved performance, strength and durability.

CONSISTENT FLEX – One-piece construction distributes flex evenly throughout the whole paddle for a smooth stroke and natural feel.

LOWER SWING WEIGHT – Elimination of materials and glues required by two-piece construction reduces weight and increases performance.



Unibody Construction



Traditional Construction

DYNELL BLADE EDGE

EXTENDED BLADE LIFE – Another AT first, Dynell edging prevents your paddle blade from wearing down.

RETAINS BLADE POWER – Use your paddle for years and not worry about losing power per stroke over time.

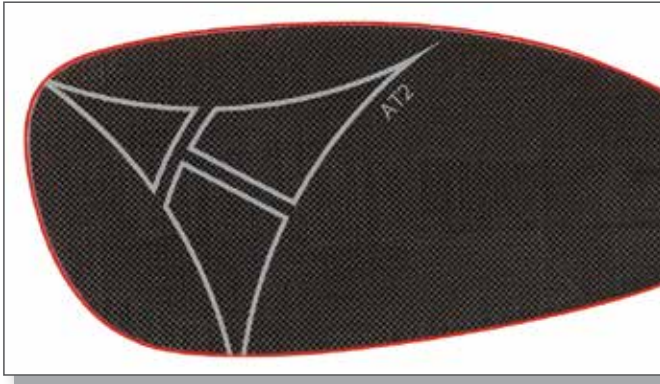

FOAM CORE BLADE

MORE CONTROL (WHITEWATER) – Blade rises to the surface. Loosen your grip – you'll know which way is up when you're rolling. Great feature for playboating or running big water.

MORE CONTROL (TOURING) – Blade is thicker and more forgiving, making it easier to move through the water. Buoyancy also makes bracing easier.

EFFICIENT & SMOOTH STROKE – Delivers an extremely smooth stroke in the water with less flutter and more energy in your stroke because it rises to the surface naturally.

LESS WEIGHT – Foam core blades are lighter than traditional blades and feel even lighter in the water.



ADJUSTABLE FERRULE SYSTEM

- **QUICK & EASY** – Simply open the lever, adjust the shaft for custom fit, and close the lever. Enjoy unlimited feathering and up to 5cm of increased length.
- **LOW WEIGHT** – Ferrule system is compact and efficient to reduce overall weight.
- **TECHNOLOGY** – Engineered for a precise fit and smooth operation. Specifically designed components for maximum compression and long-lasting durability. Made with heavy-duty fiberglass reinforced nylon and stainless steel hardware.
- **ADJUSTABLE** – Easy to remove lever makes tweaking tension a cinch.
- **HASSLE FREE MAINTENANCE** – Just pull apart, rinse with freshwater, and start planning your next trip on the water.

Go to ATpaddles.com for more information on the Adjustable Ferrule System and instructions for adjusting tension.

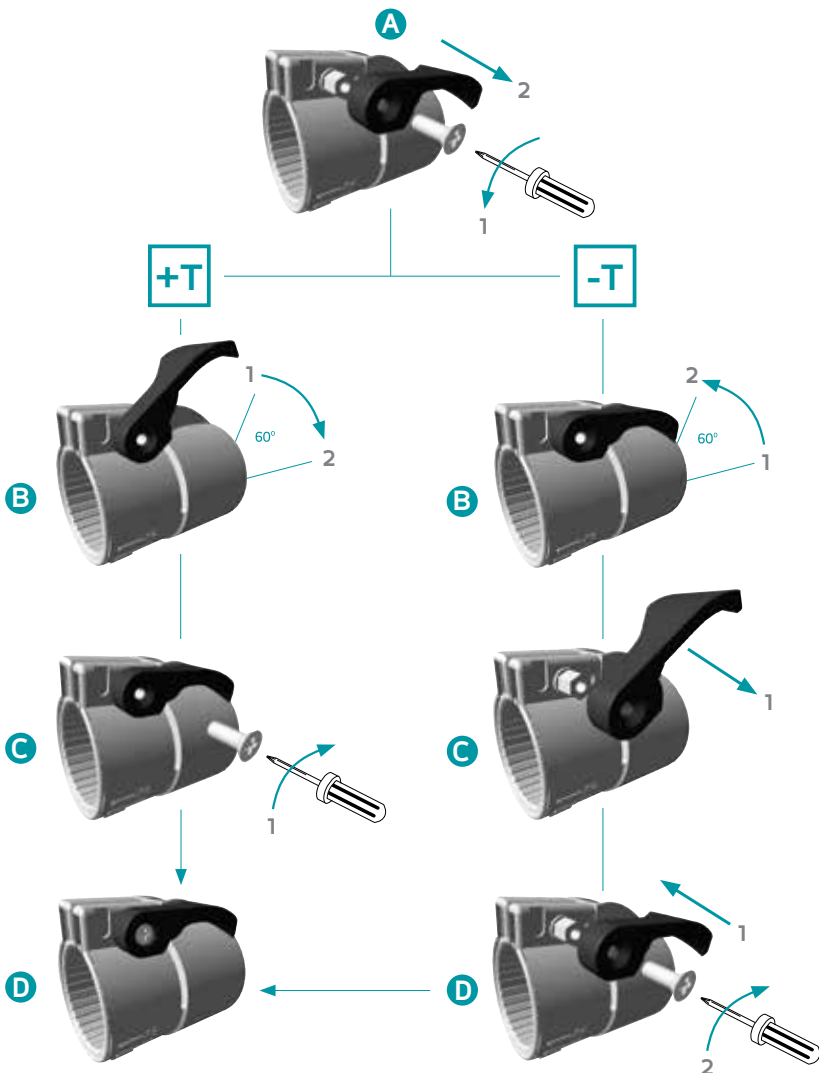

AT SIZING CHART

PADDLE LENGTH

Select AT paddles are molded with the blade and shaft as a unit. This gives our paddles their light swing weight and uniform flex. Because of this, and the importance of having the ergonomic grips in the correct place, sizing for your AT needs some extra attention. Use these standards to help. Add or subtract if your normal grip is wider or narrower. Generally, shorter people will want shorter paddles. Use the chart as a guideline unless you are familiar with the product and know exactly what you want.

WHITewater PROPER PADDLE LENGTH

RIVER RUNNING BOATERS			PLAY BOATERS			KIDS		
HEIGHT	UNDER 4' 8"	188	HEIGHT	UNDER 4' 8"	185	HEIGHT	UNDER 4' 1"	170
	4' 8" - 5' 2"	191		4' 8" - 5' 2"	188		4' 1" - 4' 1"	175
	5' 2" - 5' 8"	194		5' 2" - 5' 8"	191		4' 1" - 4' 7"	180
	5' 8" - 6' 1"	197		5' 8" - 6' 1"	194		4' 7" - 5'	185
	OVER 6'	200		OVER 6'	197			

TOURING PROPER PADDLE LENGTH

LOW ANGLE PADDLERS		BOAT WIDTH		
		UNDER 23"	23" - 28"	OVER 28"
HEIGHT	UNDER 5'	210	220	230
	5' - 5' 6"	210	220	230
	5' 6" - 6'	220	220	230
	OVER 6'	220	230	240

HIGH ANGLE PADDLERS		BOAT WIDTH		KIDS		
		UNDER 26"	OVER 26"			
HEIGHT	UNDER 5' 4"	205	210	HEIGHT	UNDER 4' 4"	185
	5' 4" - 6'	210	215		4' 4" - 4' 7"	195
	OVER 6'	215	220		4' 7" - 5'	205

ANGLER PROPER PADDLE LENGTH

STANDARD SOT			RAISED SEAT SOT		
HEIGHT	5' - 5' 6"	220	HEIGHT	5' - 5' 6"	230
	5' 6" - 6'	230		5' 6" - 6'	240
	OVER 6'	240		OVER 6'	250

CARE FOR YOUR PADDLE

AT paddles are built for years of use with little maintenance. It is recommended to complete a visual inspection after each trip. For two-piece paddles, occasionally check the ferrule system. Sand or grit can be easily cleaned by rinsing off with fresh water. Any sharp or rough spots on the edges of the paddle blades can be smoothed with fine sandpaper. Do not sand the shaft! If a gouge in a blade penetrates the fibers you can paint a little epoxy over the wound. If you are not comfortable with any paddle repair, contact us. Repairs due to abuse, negligence or normal wear may be repaired for a reasonable charge.

I'D RATHER BE PADDLING GUARANTEE

Our commitment to quality products made from durable materials is evident in every Adventure Technology paddle. That's why we offer one of the industry's strongest warranties for our products. *

If your product fails within 1 year of original purchase date due to a manufacturer defect, you can quickly receive a replacement by returning the product to the store that you bought it from or by contacting us directly. Products damaged as a result of normal wear and tear or abuse will not be covered, however may be eligible for a quick repair at a reasonable cost.

*LIMITED LIFETIME WARRANTY OFFERED ON AT2 SUPERDUTY SHAFT



**ADVENTURE
TECHNOLOGY**

U.S./GLOBAL HEADQUARTERS

Adventure Technology
575 Mauldin Road, Suite 200
Greenville, SC 29607

Tel.: 888-525-2925
Fax: 888-373-1220
ATpaddles.com

INTERNATIONAL

GERMANY, SWITZERLAND,
AUSTRIA, CZECH REPUBLIC,
SLOVAKIA, SLOVENIA, POLAND,
ITALY, DENMARK
Blue And White GmbH
Tel: +49 803690630
E-mail: info@kajak.de

JAPAN
Mont Bell
Tel: +81 (0) 6 6531 4765
Email: int@montbell.com

FINLAND, SWEDEN
Bear & Water
Tel: + 358 (0)10-4236 900
E-mail: sale@bearwater.fi

SPAIN
Outdoor Kayak
Tel: +34 973-662 092
E-mail: info@outdoor kayak.com

UNITED KINGDOM
(EXCEPT NORTHERN IRELAND)
Adventure Technology U.K.
Tel. +44 (0) 1825 765 891
E-mail info@atpaddles.co.uk

AUSTRALIA
Paddle Pro
Tel: +61 (0) 3 9546 7486
E-mail: sales@paddlepro.com.au

RUSSIA
Three Elements Company
Tel: +7 (916) 900 0263
E-mail: df@paddler.ru

SOUTH KOREA
Songkang Canoe School
Tel: +82 33 461 1659
E-mail: paddler66@naver.com

REPUBLIC OF IRELAND,
NORTHERN IRELAND
Progressive Distribution
Tel: +353 87 222 8767
E-mail: info@progressivedistribution.ie

ARGENTINA
Broni S.A.
E-mail: info@atremos.com.ar

NEW ZEALAND
Ferg's Kayaks
Tel: +64 (0) 4499 8898
E-mail: retailwn@fergskayaks.co.nz

NETHERLANDS, BELGIUM,
LUXEMBOURG
Kanocentrum Arjan Bloem
Tel: +31 (0)75-621 8805
E-mail: info@kajak.nl

NORWAY
Strie Strommer
Tel: +47 47 41 46 69
E-mail: info@striestrommer.no

Scandinavian Sports Concepts
Tel: +47 97 07 00 81
E-mail: ptr@scansports.no

INDIA
Madras Fun Tools
Tel: +91 9884814610
E-mail: info@madrasfuntools.com

